

**Be ready
for Winter**

Industrial snow chains



A quality brand





Nowadays, you need more than just quality and price to stand out from competitors. Being a market leader means having the best product, the best human resources, and of course the support of the best supplier

Comercial JOPE is continuously working to achieve excellence in the automobile accessories market with a single objective: to help our customers improve their business. Only suppliers as such as JOPE, which has extensive market experience, can help you achieve all your targets.

Immediate supply. We have enough stock to meet your orders in short time. Delivery can take between one to six days, depending on where you are located. Everything we do is designed to help you lower your storage and inventory costs and maintain the quality of your services.

Updated applications catalogue. We manage almost 2,000 different tyre cross references on which we fit our chains to check that the tyre reference numbers are correct, and that you will not have any problems. We continuously update our catalogue of tyre sizes by incorporating the new sizes that come out each year, with the result that our catalogue is one of the most copied catalogues in the market.

Technical consultation service.

Although we do our best to keep all our information fully updated, there are always some new tyre sizes in the market every year whose snow chain specifications are not known. Our Technical Consultation Service will answer all your queries immediately, either by telephone or by email.

Logistics management. When handling seasonal products such as snow chains, it is extremely important to know the status of your order and solve any problems that occur. This is why all our shipments are managed by the largest logistics operators, which means that we track your order at all times and guarantee that it will be delivered without any problems.

Consultancy. Thanks to our experience in marketing snow chains, we have acquired in-depth knowledge of the market. This means we are ideally placed to advise our customers when they are preparing their orders (sales statistics, consumption forecasts, information on trends etc.).

Commercial assistance. We provide our customers with all the resources they need to help them in their commercial activities: web page, catalogues, samples, snow alerts etc.

Index







- **page 6**
Truck/bus



- **page 12**
Light machinery



- **page 16**
Heavy machinery
and tractors



- **page 22**
Forestry
machinery



- **page 26**
Forestry
machinery/Tracks



- **page 38**
Protective
chains



- **page 46**
Forms



- **page 47**
Guarantee

Truck / Bus



E-3000



E-3000 Plus



E-Max



E-3000 Twin



V-Bar



Light trucks



Trucks



Heavy trucks



Buses



Snowploughs



Timber transport

■
Metallic chains are the most reliable solution to ensure safety of all types of vehicles when driving in adverse weather conditions with snow and ice. SNOVIT chains for buses and trucks offer the resistance and durability demanded by road transport professionals.

A wide range of chains adapted to differing needs and demands, designed for easy mounting, with guaranteed reliability, manufactured in line with the highest quality and safety standards.

E-3000



The metal chain for professional use, designed for all types of lorries and buses.



CHARACTERISTICS

- High resistance chain. Diamond-shaped tread manufactured with 20 mm, or 22.5 mm chains (depending on size). Special steel with galvanized finish.
- Lateral Chain. Interior and exterior chains manufactured, from 18.5 mm galvanized steel.
- Tensioning System. Tensioning lever with tensioning hook enabling maximum tightening of the snow chain.
- Elastic rubber tensor. Elastic rubber tensor used to fit the chain, increasing the chain tension as well as fixing the surplus chain.

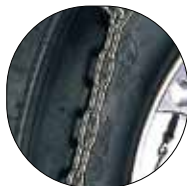

PACKING

Raffia bag. Printed design. Stitched handles for easy handling. Label inserted with list of applications and bar code. Nylon cord around the top of the bag with rapid open/close system. Includes parts kit. 1 pair in a bag.

E-3000 Plus



Truck chain with reinforced links. Reinforced for intensive use.



CHARACTERISTICS

- Link thickness of 4.5 mm, 5.5 mm, 7 mm or 8 mm.
- Running surface in rhomboid shape made of special alloy steel, with "D" profile links for safe grip on snow and ice.
- High quality heat treatment – carburising.
- Reinforced with additional "D" profile links for better grip and durability.
- Operating instructions enable fast assembly.



PACKING

Raffia bag. Printed design. Stitched handles for easy handling. Label inserted with list of applications and bar code. Nylon cord around the top of the bag with rapid open/close system. Includes parts kit. 1 pair in a bag.

E-Max



Cargo vehicle chains, intended for wood transportation and winter services.



CHARACTERISTICS

- Chains are net woven and made of special alloy steel for a safer grip on snow and ice.
- High quality heat treatment – carburising.
- Chain links made of "D" profile wire with a thickness of 7 mm.
- In the desire to wear the edge of the tyre less, the connections to the tread part of the chain are made of chain of a round profile of 7 mm.
- Chains can be used on both sides which significantly improves durability.



PACKING

Raffia bag. Printed design. Stitched handles for easy handling. Label inserted with list of applications and bar code. Nylon cord around the top of the bag with rapid open/close system. Includes parts kit. 1/2 pair in a bag.



E-3000 Twin



For dual wheels, with asymmetric net. Ideal for longer, uninterrupted use.



CHARACTERISTICS

- Link thickness of 4.5 mm, 5.5 mm, 7 mm or 8 mm.
- Running surface in asymmetric rhomboid shape made of special alloy steel, with "D" profile links for safe grip on snow and ice.
- High quality heat treatment – carburising.



PACKING

Raffia bag. Printed design. Stitched handles for easy handling. Label inserted with list of applications and bar code. Nylon cord around the top of the bag with rapid open/close system. Includes parts kit. 1 pair or 1/2 pair in a bag depending on the size.

V-Bar



Chain for difficult conditions. Lightweight manageable chain for medium powered vehicles with a transversal tread band. For continuous and demanding use on ice and snow.

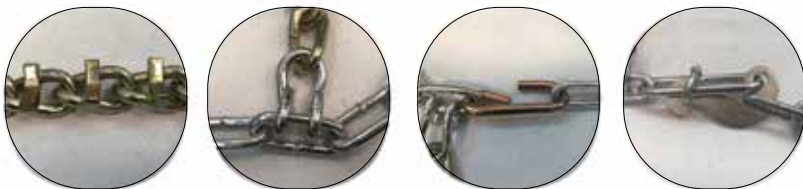

CHARACTERISTICS

- Special high resistance chain. Tread manufactured with 25-mm or 28-mm (depending on size) twisted -dichromate chain with V-shaped icebreaker finish.
- Side chain. Galvanised-steel interior and exterior chains.
- Tensioning system. Circular rubber with fastening hooks to tighten the snow chain to the maximum.



PACKING

Raffia bag. Printed design. Stitched handles for easy handling. Label inserted with list of applications and bar code. Nylon cord around the top of the bag with rapid open/close system. Includes parts kit. ½ pair in a bag.

Light machinery



ATV



ATV Plus



E-Max



Forklift truck



Minitractor



Quad



Snowplough

■ Chains specially designed for use on ATV vehicles and light machinery on terrain with mud and snow, providing considerably improved grip and safety when driving.

Manufactured using long-lasting materials which guarantee high resistance and durability, even in the most extreme conditions.

ATV



■ For garden machinery and manual snow blowers. For light to moderate use in winter conditions. Running surface in rhomboid shape.



CHARACTERISTICS

- Link thickness of 3.5 mm, 4.5 mm or 5.5 mm, with a "D" profile link, which ensures a safe grip on snow and ice.
- Special alloy steel.
- High quality heat treatment – carburising.
- The chain is fully galvanized.
- Equipped with a tensioning chain and tensioning hook.

PACKING

■ Raffia bag. Printed design. Stitched handles for easy handling. Label inserted with list of applications and bar code. Nylon cord around the top of the bag with rapid open/close system. Includes spare parts kit. 1 pair per bag.

ATV Plus



For forklifts and smaller tractors, intended for moderate to demanding use. Running surface in twin asymmetric rhomboid shape with reinforced chain links.



CHARACTERISTICS

- Link thickness of 4.5 mm or 5.5 mm, with a "D" profile link, which ensures a safe grip on snow and ice.
- Special alloy steel.
- High quality heat treatment – carburising.
- The chain is fully galvanized.
- Equipped with a tensioning chain and tensioning hook.



PACKING

Raffia bag. Printed design. Stitched handles for easy handling. Label inserted with list of applications and bar code. Nylon cord around the top of the bag with rapid open/close system. Includes parts kit 1 pair in a bag.

E-Max



Suitable for light mobile machinery, e.g. forklifts and smaller loaders. Designed for unfavourable conditions and ensuring optimum grip in snow and ice.



CHARACTERISTICS

- Approved in accordance with the ON V5119 standard.
- Chains are net woven and made of special alloy steel for a safer grip on snow and ice.
- High quality heat treatment – carburizing.
- Chain links made of "D" profile wire with a thickness of 4,5 mm or 5,5 mm.
- Chains can be used on both sides which significantly improves durability.



PACKING

Raffia bag. Printed design. Stitched handles for easy handling. Label inserted with list of applications and bar code. Nylon cord around the top of the bag with rapid open/close system. Includes spare parts kit 1 pair per bag.

Heavy machinery and tractors



Traktor



Machinery



Machinery Plus



Top Grip



Loader



Forestry tractor



Forestry loader



Processor



Skidder



Self-loader



Tractor



The tough working conditions and complicated terrain in which heavy machinery and tractors operate require solutions which improve performance and guarantee the safety of the professionals who use them.

For this reason, SNOVIT offers a range of chains specially designed and manufactured to provide excellent performance, guaranteeing reliability and suitable for various types of machinery.

Traktor



Ladder-shaped chain, for light agricultural use. Simple and functional. With reinforced rings on longitudinal links.



CHARACTERISTICS

- Link thickness of 6 mm, 7 mm, 8 mm, or 9.5 mm, with a “D” profile link for a safe grip on snow and ice.
- High quality heat treatment – carburizing. Fully galvanized.
- Inner side chain with adjustable shackles for an optimal fit on the tyre.
- Equipped with a tensioning chain and tensioning hook.
- Not suitable for use by winter services.



PACKING

Supplied in a durable rafia bag or wooden crate, depending on the size.

Machinery



Rhomboid-shaped chain, ideal for standard agricultural use.



CHARACTERISTICS

- Link thickness of 7 mm, 8 mm, or 9.5 mm, with a “D” profile link for a safe grip on snow and ice.
- High quality heat treatment – carburizing. Fully galvanized.
- Inner side chain with adjustable shackles for an optimal fit on the tyre.
- Equipped with a tensioning chain and tensioning hook.
- The running and side surfaces are connected by welded rings.



PACKING

Supplied in a durable raffia bag or wooden crate, depending on the size.

Machinery Plus



Dense rhomboid-shaped chain, ideal for professional use in winter conditions. With reinforced links, for constant use on snow and ice. Ideal for snowploughing vehicles.



CHARACTERISTICS

- Link thickness of 7 mm, 8 mm, or 9.5 mm, with a “D” profile link for a safe grip on snow and ice.
- High quality heat treatment – carburizing. Fully galvanized.
- Inner side chain with adjustable shackles for an optimal fit on the tyre.
- Equipped with a tensioning chain and tensioning hook.
- The running and side surfaces are connected by welded rings.



PACKING

Supplied in a durable raffia bag or wooden crate, depending on the size.

Top Grip



Dense rhomboid-shaped chain, ideal for professional use in extreme winter conditions and in forestry. The chain is primarily designed for heavy cranes that need a good grip, rather than a high level of protection.



CHARACTERISTICS

- Link thickness of 7 mm, 8 mm or 9.5 mm with a “D” profile link for a secure grip on snow and ice
- High quality heat treatment – carburizing. Fully galvanized.
- Inner side chain with adjustable shackles for an optimal fit on the tyre.
- Equipped with a tensioning chain and tensioning hook.
- The running and side surfaces are connected by welded rings.



















PACKING

1 pair in a wooden crate.



Applications

	E-3000	E-3000 Plus	E-Max	E-3000 Twin	V-Bar	ATV	ATV Plus	E-Max ATV	Traktor	Machinery	Machinery Plus	Top Grip	Forest Grip	Forest Xtrem	Forest ring	Track
 Forklift truck						●	●	●								
 Minitractor						●	●	●								
 Quad						●	●	●								
 Snowplough						●	●	●								
 Light trucks	●	●	●	●	●											
 Trucks	●	●	●	●	●											
 Heavy trucks	●	●	●	●	●											
 Buses	●	●	●													
 Snowploughs			●													
 Timber transport			●	●												
 Tractor									●	●			●	●		
 Loader										●	●	●				
 Forestry tractor											●	●				
 Forestry loader											●	●				
 Processor											●	●	●	●		●
 Self-loader													●	●		●
 Skidder											●	●	●	●	●	

Forestry machinery



Forest Skider



Forest Extreme



Ring



Tractor



Processor



Self-loader



Skidder

Working in forests and uncrossable terrain is a challenge which can involve obstacles and unexpected situations. Reliability and resistance are crucial factors for safe and efficient work in the forestry sector, a challenge guaranteed by the SNOVIT forestry chain range.

Designed to guarantee maximum grip and traction, these offer high tyre protection and optimum durability thanks to the high resistance materials used in their manufacture. A range of chains adaptable to all styles of vehicle and for all types of terrain.

Forest Grip

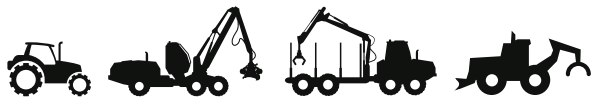

■ The chain is intended for storage and removal of wood. It is distinguished by good grip and tyre protection. Suitable for all terrains, particularly softer ones.

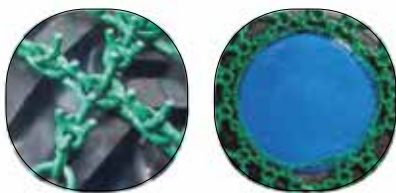

CHARACTERISTICS

- Made of special alloy steel and fully heat treated, which extends its life span additionally.
- Available in 11 mm, 14 mm and 16 mm versions.
- The chain has a tensioning system, which enables use on all types of tyres and adjustment to worn tyres.
- Installation instructions and spare parts are included.

Possibility of providing chains with a combination of forged “S” profile pieces and rings. It is intended for work in difficult conditions, mainly on rocky and harder surfaces.

- Distinguished by minimal sideways sliding, good tyre protection and minimal damage to the surface on which it is used.
- Available in 11 mm, 14 mm, 16 mm and 18 mm versions.
- Due to its construction and forged parts, it cleans itself during driving.



PACKING

■ 1 pair in a wooden crate.

Forest Xtrem



The chain is intended for storage and removal of wood. It is distinguished by good grip and tyre protection. Suitable for all terrains, particularly softer ones.

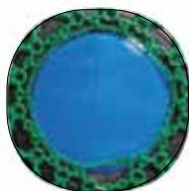

CHARACTERISTICS

- Ensures exceptional grip, stability and tyre protection.
- Made of special heat treated (cemented) steel alloy. This treatment makes the material extra tough and extends the lifetime of the chain.
- The chain is available in 11 mm, 14 mm and 16 mm.
- Equipped with a tensioning system for use on all types of tyres and for adaptation to tyre wear.
- Lighter, self-cleaning construction.
- Fitting instructions and spare parts included.

Possibility of providing chains with a combination of forged "S" profile pieces and rings. It is intended for work in difficult conditions, mainly on rocky and harder surfaces.

- Distinguished by good grip, vehicle stability and optimal tyre protection.
- Available in 11 mm, 14 mm, 16 mm and 18 mm versions.



PACKING

1 pair in a wooden crate.

Forest Ring



H-shaped chain for use in light agricultural work. With reinforced rings in longitudinal arms.



CHARACTERISTICS

- Improved traction on both hard and soft ground.
- Designed for extreme conditions.
- High alloy steel traction ring with a thickness of 27 mm - 32 mm.
- Diameter 200 mm - 220 mm.
- Chain with round links of 15 mm - 18 mm.
- The entire chain is made of special boron alloy steel.
- Chains are hardened to minimize wear of the material.
- Coated surface. Designed for excellent traction on all types of terrain.



PACKING

1 pair in a wooden crate.

Forestry machinery-Tracks



Track Multi



Track Groove



Track Soft



Track Extrem



Track Combo MS



Track Combo GS



Track Combo ES



Track Mega



W-Track Multi



W-Track Groove



W-Track Soft



Processor



Self-loader

■ The complexity of forest terrains requires specialized machinery capable of increasing productivity with the minimum of environmental damage.

Our range of Tracks can be adapted to all types of terrain, and provide extended tyre life of up to 60% together with a reduction in fuel consumption compared with other brands, as well as reduced pressure on the ground of up to 50%, all combining to offer extreme traction and resistance thanks to the boron steel manufacture.

Track Multi



■ Universal profile form, which permits excellent traction and stability of the machine on various types of ground. Suitable for steep and stony terrains and also for mud and snow.



Ø 26mm



20mm



■ APPLICATION:

- Demanding and rocky terrain.
- Mud and snow.

■ PRODUCT PROPERTIES:

- Optimum grip on different types of ground.
- The tread shape enables an excellent grip between the pneumatic tyre and track.
- The structure enables automatic cleaning while driving.
- Heat-treated material, which reduces the wear on the tracks.

■ TECHNICAL FEATURES:

- Option of adjusting the tension on the track.
- Simple shortening/lengthening of the track.
- As it aligns itself with the pneumatic tyre, it extends its service life.
- Option of welding additional cogs.
- Option of zinc-plating
- Option of Ø22mm and Ø30mm connectors

■ PACKING

Complete Track set supplied in 2 pallets.

Track Groove



Special form of a profile, which enables an excellent traction and stability of the machine on various types of the foundation.

It is appropriate for steep and stony terrains and also for mud and snow.



APPLICATION:

- Demanding and rocky terrain.
- Mud and snow.

PRODUCT PROPERTIES:

- Optimum grip on different types of ground.
- The tread shape enables an excellent grip between the pneumatic tyre and track.
- The structure enables automatic cleaning while driving.
- Heat-treated material, which reduces the wear on the tracks.

TECHNICAL FEATURES:

- Option of adjusting the tension on the track.
- Simple shortening/lengthening of the track.
- As it aligns itself with the pneumatic tyre, it extends its service life.
- Option of welding additional cleats.
- Option of zincifying.
- Option of Ø22mm and Ø30mm connectors.



PACKING

Complete Track set supplied in 2 pallets.

Track Soft



Due to the form of the profile it enables great contact surface with the forest soil, and, consequentially, also an outstanding traction and stability of the machine on swampy and soft foundations. The profile with the least influence to the forest soil.

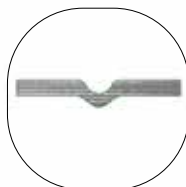

APPLICATION:

- Soft and marshy terrain.
- On terrain where minimum impact on the environment and undergrowth must be ensured.

PRODUCT PROPERTIES:

- Optimum grip on different types of ground.
- The tread has been designed to have the least impact on the forest floor.
- The tread shape enables an excellent grip between the pneumatic tyre and track.
- The structure enables automatic cleaning while driving.
- Heat-treated material, which reduces the wear of tracks.

TECHNICAL FEATURES:

- Option of adjusting the tension on the track.
- Simple shortening/lengthening of the track.
- As it aligns itself with the pneumatic tyre, it extends its service life.
- Option of welding additional cogs.
- Option of zincifying.
- Option of Ø22mm and Ø30mm connectors.

PACKING

Complete Track set supplied in 2 pallets.

Track Xtrem



Tracks are intended for the most challenging terrains. The construction of the profile enables outstanding traction and stability of the machine on steep terrains as well as constant traction between the tyre and the tracks.



APPLICATION:

- Demanding and rocky terrain.
- Tread for the steepest terrain.

PRODUCT PROPERTIES:

- Optimum grip on hard and rocky terrain.
- The tread shape enables an excellent grip between the pneumatic tyre and track.
- The structure enables automatic cleaning while driving.
- Heat-treated material, which reduces the wear of tracks.

TECHNICAL FEATURES:

- Option of adjusting the tension on the track.
- Simple shortening/lengthening of the track.
- As it aligns itself with the pneumatic tyre, it extends its service life.
- Option of welding additional cogs.
- Option of zincifying.
- Option of Ø22mm and Ø30mm connectors.

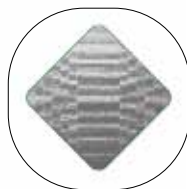

PACKING

Complete Track set supplied in 2 pallets.

Track Combo MS



The combination of the profiles MULTI and SOFT. Tracks offer greater traction also on the changing terrain.



APPLICATION:

- Demanding terrain.
- Mud and snow.
- Soft or soggy terrain.

PRODUCT PROPERTIES:

- Optimum grip on different types of ground.
- The tread shape enables an excellent grip between the pneumatic tyre and track.
- The structure enables automatic cleaning while driving.
- Heat-treated material, which reduces the wear of tracks.

TECHNICAL FEATURES:

- Option of adjusting the tension on the track.
- Simple shortening/lengthening of the track.
- As it aligns itself with the pneumatic tyre, it extends its service life.
- Option of welding additional cogs.
- Option of zincifying.
- Option of Ø22mm and Ø30mm connectors

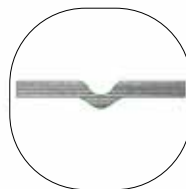
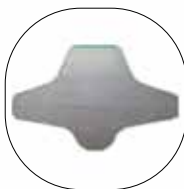

PACKING

Complete Track set supplied in 2 pallets.

Track Combo GS



■ The combination of the profiles GROOVE and SOFT. Tracks also offer greater traction on changing terrain.



APPLICATION:

- Demanding terrain.
- Mud and snow.
- Soft or soggy terrain.

PRODUCT PROPERTIES:

- Optimum grip on different types of ground.
- The tread shape enables an excellent grip between the pneumatic tyre and track.
- The structure enables automatic cleaning while driving.
- Heat-treated material, which reduces the wear of tracks.

TECHNICAL FEATURES:

- Option of adjusting the tension on the track.
- Simple shortening/lengthening of the track.
- As it aligns itself with the pneumatic tyre, it extends its service life.
- Option of welding additional cleats.
- Option of zincifying.
- Option of Ø22mm and Ø30mm connectors.

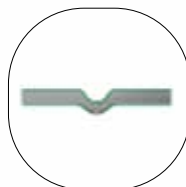

■ PACKING

Complete Track set supplied in 2 pallets.

Track Combo ES



The combination of the profiles EXTREM and SOFT. Tracks offer greater traction also on the changing terrain.



APPLICATION:

- Demanding terrain.
- Mud and snow.
- Soft or soggy terrain.

PRODUCT PROPERTIES:

- Optimum grip on different types of ground.
- The tread shape enables an excellent grip between the pneumatic tyre and track.
- The structure enables automatic cleaning while driving.
- Heat-treated material, which reduces the wear of tracks.

TECHNICAL FEATURES:

- Option of adjusting the tension on the track.
- Simple shortening/lengthening of the track.
- As it aligns itself with the pneumatic tyre, it extends its service life.
- Option of welding additional cleats.
- Option of zinc-plating.
- Option of Ø22mm and Ø30mm connectors.



PACKING

Complete Track set supplied in 2 pallets.

Track Mega



The profile MEGA is an upgrade of the SOFT profile. It is developed for the conditions where additional surface of tracks is necessary – on very soggy terrains and greater side stability of the machine.

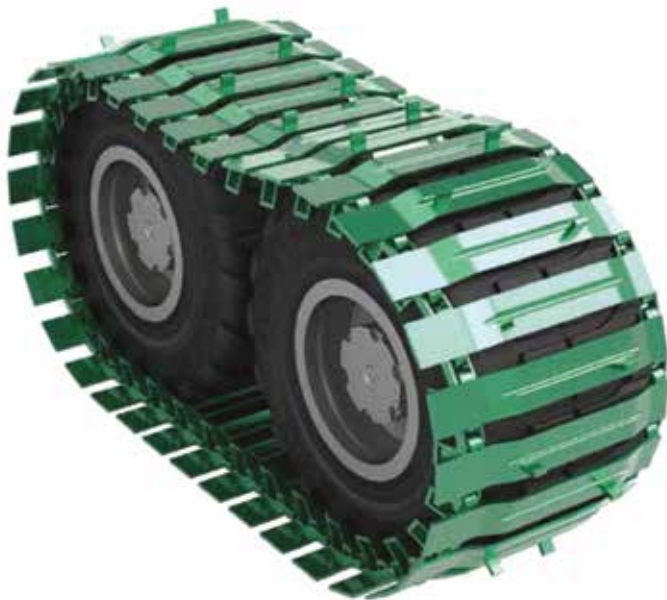

APPLICATION:

- Soft and marshy terrain.
- On terrain where minimum impact on the environment and undergrowth must be ensured.

PRODUCT PROPERTIES:

- Optimum grip on different types of ground.
- The tread has been designed to have the least impact on the forest floor.
- The tread shape enables an excellent grip between the pneumatic tyre and track.
- Option of lengthening the profile to both sides
- The structure enables automatic cleaning while driving.
- Heat-treated material, which reduces the wear of tracks.

TECHNICAL FEATURES:

- Option of adjusting the tension on the track.
- Simple shortening/lengthening of the track.
- As it aligns itself with the pneumatic tyre, it extends its service life.
- Option of welding additional cleats.
- Option of zincifying.
- Option of Ø22mm and Ø30mm connectors.

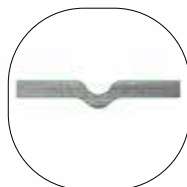

PACKING

Complete Track set supplied in 2 pallets.

W-Track Multi



Intended for the six-wheel forestry machines, which are meant to protect the tyres and assure better traction in the most challenging conditions. Universal form of the profile, which enables outstanding traction and stability of the machine on various types of surface. It is appropriate for steep and stony terrains and also for mud and snow.

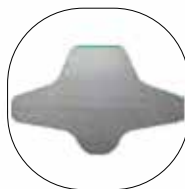

APPLICATION:

- Demanding and rocky terrain.
- Tread for the steepest terrain.
- Substitute and upgrade of forestry chains.

PRODUCT PROPERTIES:

- Optimum grip on different types of ground.
- The tread shape enables an excellent grip between the pneumatic tyre and track.
- Heat-treated material, which reduces the wear of tracks.

TECHNICAL FEATURES:

- Simple shortening/lengthening of the track.
- Option of welding additional cleats.
- Option of zincifying.
- Option of Ø22mm and Ø30mm connectors

PACKING

One set supplied on 1 pallet.

W-Track Groove



Special form of a profile, which enables an excellent traction and stability of the machine on various types of the foundation. It is appropriate for steep and stony terrains and also for mud and snow.



APPLICATION:

- Demanding and rocky terrain.
- Mud and snow.

PRODUCT PROPERTIES:

- Optimum grip on different types of ground.
- The tread shape enables an excellent grip between the pneumatic tyre and track.
- The structure enables automatic cleaning while driving.
- Heat-treated material, which reduces the wear of tracks.

TECHNICAL FEATURES:

- Option of adjusting the tension on the track.
- Simple shortening/lengthening of the track.
- As it aligns itself with the pneumatic tyre, it extends its service life.
- Option of welding additional cleats.
- Option of zincifying.
- Option of Ø22mm and Ø30mm connectors.

PACKING

One set supplied on 1 pallet.

W-Track Soft



Intended for the six-wheel forestry machines, which are meant to protect the tyres and assure better traction in the most challenging conditions. Due to the form of the profile, it enables a great contact surface with the forest soil, and, consequently, also an outstanding traction and stability of the machine on swampy and soft foundations. The profile with the least influence to the forest soil.

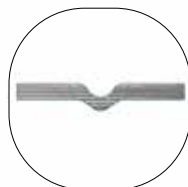

APPLICATION:

- Soft and marshy terrain.
- On terrain where minimum impact on the environment and undergrowth must be ensured.
- Substitute and upgrade of forestry chains.

PRODUCT PROPERTIES:

- Optimum grip on different types of ground.
- The tread has been designed to have the least impact on the forest floor.
- The tread shape enables an excellent grip between the pneumatic tyre and track.
- Heat-treated material, which reduces the wear of tracks.

TECHNICAL FEATURES:

- Simple shortening/lengthening of the track.
- Option of welding additional cleats.
- Option of zincifying.
- Option of Ø22mm and Ø30mm connectors.



PACKING

One set supplied on 1 pallet.

Protective chains



TPC-GN



TPC-GX



TPC-GP



TPC-RNG



TPC-SN



TPC-KRP



Dump truck



Loader



The reliability of the protection chains ensures maximum safety and continued mining activity without tyre problems producing an impediment to the efficient operation of the machinery.

Cuts, punctures and other damage to tyres are one of the greatest risks for this type of machinery and can be avoided by using our range of protective chains, manufactured with different lattices and protectors which can extend the active life of the tyre by up to 50%.

TPC-GN



With the use of protection chains, we can protect tyres from damage and extend their active life by up to 40-50%.

The active life of the protection chains depends on the correct thermal treatment of the components. The hardness of the nucleus ensures the toughness of the material. This is vitally important for heavy loads and the durability of the chain. We ensure the desired characteristics with our hardening processes.

The material must be correctly suited to thermal production and contain the correct proportions of carbon and other alloy elements, which combine to produce high quality materials with optimum hardness. In addition to their protective qualities, the chains also provide improved adhesion and reduce the possibility of the wheel slipping.

TECHNICAL SPECIFICATIONS:

- The shape of forgings with which it is possible to choose any form of knitting.
- The forging has reliefs so that in addition to protecting the tyre, it also offers better grip.
- In addition to better grip, the shape also enables better heat processing of the forging – longer lifetime of the chain.

PURPOSE:

- Construction.
- Quarry.
- Surface mines.
- Mines.

FUNCTIONALITY:

- Due to the serrated shape, in addition to protection, it also offers improved grip.

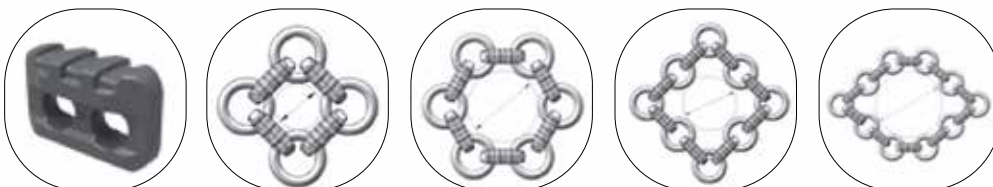

TPC-GX



With the use of protection chains, we can protect tyres from damage and extend their active life by up to 40-50%.

The active life of the protection chains depends on the correct thermal treatment of the components. The hardness of the nucleus ensures the toughness of the material. This is vitally important for heavy loads and the durability of the chain. We ensure the desired characteristics with our hardening processes.

The material must be correctly suited to thermal production and contain the correct proportions of carbon and other alloy elements, which combine to produce high quality materials with optimum hardness. In addition to their protective qualities, the chains also provide improved adhesion and reduce the possibility of the wheel slipping.



TECHNICAL CHARACTERISTICS:

- The shape of forgings with which it is possible to choose any form of knitting.
- The forging has no relief and therefore a larger contact surface that offers greater tyre protection and a stable ride.
- Due to the reduced relief, it has poorer grip than other forgings.

PURPOSE:

- Construction.
- Dump sites.
- Slag.
- Surface mines.
- Mines.

FUNCTIONALITY:

- The shape of the protective element allows for better protection of the tyre.

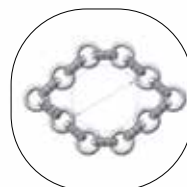
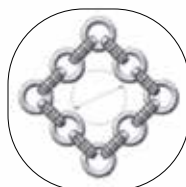
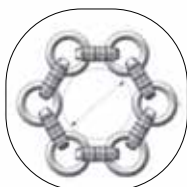
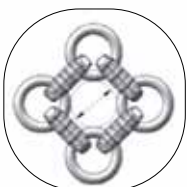

TPC-GP



With the use of protection chains, we can protect tyres from damage and extend their active life by up to 40-50%.

The active life of the protection chains depends on the correct thermal treatment of the components. The hardness of the nucleus ensures the toughness of the material. This is vitally important for heavy loads and the durability of the chain. We ensure the desired characteristics with our hardening processes.

The material must be correctly suited to thermal production and contain the correct proportions of carbon and other alloy elements, which combine to produce high quality materials with optimum hardness. In addition to their protective qualities, the chains also provide improved adhesion and reduce the possibility of the wheel slipping.



TECHNICAL CHARACTERISTICS:

- The shape of forgings with which it is possible to choose any form of knitting.
- The forging has no relief and therefore a larger contact surface that offers greater tyre protection and a stable ride.
- Due to reduced relief, it has poorer grip than other forgings.
- Because it is intended for lighter machines, the surface of the forging is smaller, making the chain a little lighter.

PURPOSE:

- Construction.
- Quarry.
- Surface mines.
- Mines.

FUNCTIONALITY:

- Due to the serrated shape, in addition to protection, it also offers improved grip.

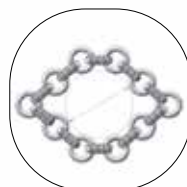
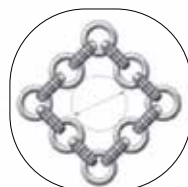
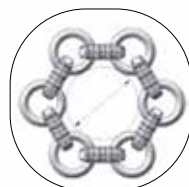
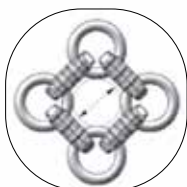

TPC-RNG



With the use of protection chains, we can protect tyres from damage and extend their active life by up to 40-50%.

The active life of the protection chains depends on the correct thermal treatment of the components. The hardness of the nucleus ensures the toughness of the material. This is vitally important for heavy loads and the durability of the chain. We ensure the desired characteristics with our hardening processes.

The material must be correctly suited to thermal production and contain the correct proportions of carbon and other alloy elements, which combine to produce high quality materials with optimum hardness. In addition to their protective qualities, the chains also provide improved adhesion and reduce the possibility of the wheel slipping.



TECHNICAL CHARACTERISTICS:

- The shape of the forgings with which it is possible to choose only the densest knitting.
- The forging has no relief and therefore a larger contact surface that offers greater tyre protection and a stable ride.
- The dense knitting enables improved grip.

PURPOSE:

- Dump sites.
- Quarry.
- Surface mine.
- Mines.

FUNCTIONALITY:

- Due to its shape, it offers better protection of the tyre – it increases the distance from the surface.

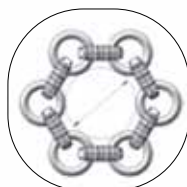
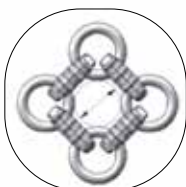

TPC-SN



With the use of protection chains, we can protect tyres from damage and extend their active life by up to 40-50%.

The active life of the protection chains depends on the correct thermal treatment of the components. The hardness of the nucleus ensures the toughness of the material. This is vitally important for heavy loads and the durability of the chain. We ensure the desired characteristics with our hardening processes. The material must be correctly suited to thermal production and contain the correct proportions of carbon and other alloy elements, which combine to produce high quality materials with optimum hardness. In addition to their protective qualities, the chains also provide improved adhesion and reduce the possibility of the wheel slipping.

TECHNICAL CHARACTERISTICS:

- The shape of forgings with which it is possible to choose any form of knitting.
- The forging has no relief and therefore a larger contact surface that offers greater tyre protection and a stable ride.
- Due to reduced relief, it has poorer grip than other forgings.
- Because it is intended for lighter machines, the surface of the forging is smaller, making the chain a little lighter.

PURPOSE:

- Dump sites,
- Ironworks.

FUNCTIONALITY:

- Due to its profile, it offers greater tyre protection.

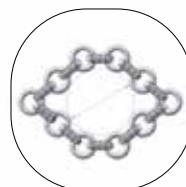
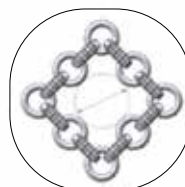
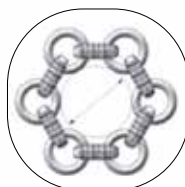
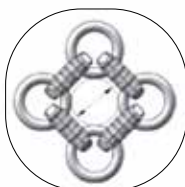

TPC-KRP



With the use of protection chains, we can protect tyres from damage and extend their active life by up to 40-50%.

The active life of the protection chains depends on the correct thermal treatment of the components. The hardness of the nucleus ensures the toughness of the material. This is vitally important for heavy loads and the durability of the chain. We ensure the desired characteristics with our hardening processes.

The material must be correctly suited to thermal production and contain the correct proportions of carbon and other alloy elements, which combine to produce high quality materials with optimum hardness. In addition to their protective qualities, the chains also provide improved adhesion and reduce the possibility of the wheel slipping.

TECHNICAL CHARACTERISTICS:

- The shape of forgings with which it is possible to choose any form of knitting.
- The forging has a large relief so that in addition to protecting the tyre, it also greatly improves grip.
- The shape of the profile allows for better heat treatment – longer lifetime of the tyre.

PURPOSE:

- Construction.
- Quarry.
- Surface mines.
- Mines.

FUNCTIONALITY:

- Due to the serrated shape, in addition to protection, it also offers improved grip.

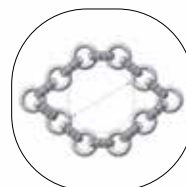
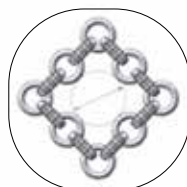
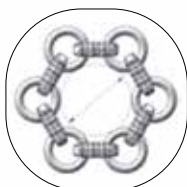
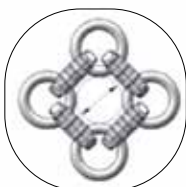

Forms

Track

Machine



Brand: _____

Type: _____

Weight: _____

Rock

- Steep terrain
- Rocky terrain
- Demanding terrain
- Uneven terrain
- Soft terrain
- Very soft terrain

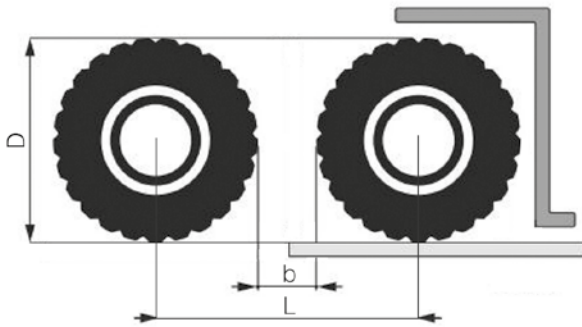
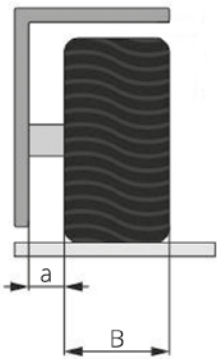

D: _____ mm.

B: _____ mm.

L: _____ mm.

a: _____ mm.

b: _____ mm.

Tyre protection chain

Machine

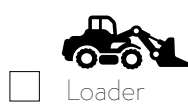

Brand: _____

Type: _____

Weight: _____

Tyre

Dimension: _____ Brand: _____

Tread: _____ Type: _____

Rock

Type Rock: _____

Hardness: _____

Percentage of quartz: _____

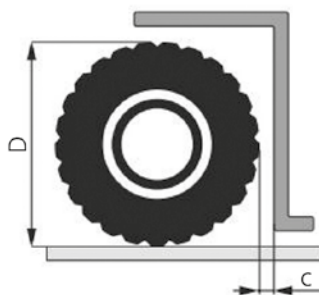
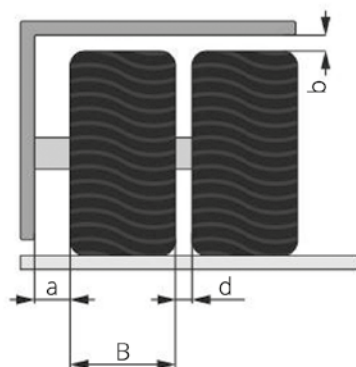
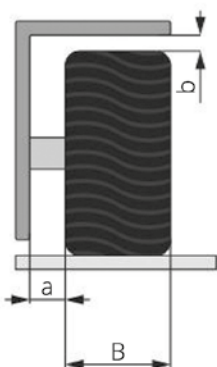

a: _____ mm.

b: _____ mm.

B: _____ mm.

c: _____ mm.

d: _____ mm.

D: _____ mm.

Snovit Product Guarantee

Snovit products are all supplied with a two-year legal guarantee of conformity under the terms of consumer protection laws in the country of sale.

In accordance with current legislation, consumers have the right to obtain from the seller, and where applicable the manufacturer, the repair or free replacement of any products which show a lack of conformity with standards and specifications within 24 months from product delivery, always provided the non-conformity existed when the product arrived and there is no evidence of misuse

What is a lack of conformity?

Claims can be made against a product under the following circumstances:

- It is not suitable for the normal uses for which this type of product is designed.
- It does not conform with the description supplied by the seller and does not possess the product qualities which the seller presented to the consumer either in demonstration or according to model specifications.
- It does not exhibit the quality and performance of a product of this type which the consumer and user may reasonably expect, taking into account both the nature of the product and, where applicable, all published declarations on the specific characteristics of the product as made by the retailer, the manufacturer or their representatives, in particular through advertising or labelling.
- It is not suitable for any special purpose required by the consumer when this was made known to the seller prior to the sale agreement and where the latter had declared the product to be suitable for the said use.

How and when may the consumer execute the rights defined under the legal guarantee?

A consumer may claim the rights deriving from a legal guarantee through lack of conformity existing at the time of delivery of the product or that exhibited up to 24

months from delivery of the same. Except in the case of misuse, after examination by qualified technical personnel, it may be assumed that any lack of conformity exhibited during the 6 months following delivery already existed at the time of delivery, except where this assumption is incompatible with the nature of the product or the type of non-conformity. All consumers may benefit from the legal guarantee provided they can produce proof of purchase of the item (through an invoice or receipt for example).

What is the procedure to follow in the event of a lack of conformity?

Should the customer or end user become aware of a lack of conformity in a Snovit product, they should immediately contact the retailer or distributor from whom they purchased the item in order to claim their legal rights in accordance with current legislation.

Our Customer Service Department will verify whether complaints received from distributors, retailers and end users comply with the terms and conditions defined under existing consumer protection laws. If the issue requires a technical analysis to determine whether a lack of conformity exists, a complaints procedure will be opened based on a request for information (generally an image of the non-conforming product), which may include the withdrawal of the product for inspection.

If it is determined that the conditions specified under current Law are met, the customer will then have the right to demand repair or free replacement from Snovit of the non-conforming product, except where the form of rectification requested is objectively impossible or disproportionate, taking into account the value of the product and the possibility of implementing an alternative remedy without further inconvenience to the customer.

ATENCIÓN AL CLIENTE
clientes@snovit.eu



COMERCIAL JOPE S.L | Polígono Industrial de Egüés, Calle Z, nº 25 | 31486 EGÜÉS | NAVARRA | SPAIN
Tel. (+34) **948 331 313** | e-mail: info@snovit.eu | www.snovit.eu



HORNREINENCO REF: 60008 09/2020

